



PRODUCTIVE

INDUSTRIAL SYSTEMS

High-tech with a tradition

For nearly 100 years, FESSMANN has been standing for cutting-edge high-tech systems for the treatment of food in the meat and fish processing industry.

FESSMANN was founded in Winnenden near Stuttgart in 1924. Today, the company is represented in more than 50 countries on all continents of the world. So far, FESSMANN has already supplied over 80,000 systems for smoking, cooking, roasting, baking and cooling. The trust that our customers place in our process engineering is what keeps us going. There is a reason that FESSMANN is an international leader in quality and service.

Each day we strive to improve even further - not only the flavour aspect but also ecologically and economically. This is how we make the environment, you and your customers happy: Our passion for quality goes beyond mere taste. It also improves your margins. How? Find out on the following pages.





Dates and facts

- 1924** Company founded by Wilhelm Fessmann
- 1969** Delivery of the first TURBOMAT universal system
- 1971** Development of TF3000, the first semi-continuous system
- 1972** Development of the first transfer system
- 1976** FESSMANN Technical School opens
- 1982** Development of the first RATIO smoke generator
- 1993** The patented RATIO-TOP smoulder smoke generator completes the RATIO line
- 1998** FESSMANN develops equipment for cooking and baking: AUTOVENT and RotathermCARAT
- 2003** The TF4000 now also allows for the continuous production of sausage with natural casings
- 2004** FESSMANN introduces a real all-rounder: the Ti3000 industrial system
- 2007** TF4000 is equipped with **TRANS.CON**, a new control generation
- 2008** A development success for FESSMANN: the **ECO.LINE** with Triplex insulation, CIP cleaning and frequency converter
- 2010** The new **FOOD.CON** control and the new RATIO-STEAM steam smoke generator are introduced at IFFA

FESSMANN systems offer more

Consistency in form, taste and quality

Good sausage is characterised by the unique taste experience that it offers. This dedication to quality must be met with excellent technology and a well thought-out concept. Reproducible and reliable products can only be achieved with continuous development and enhancements. This is what customers appreciate about FESSMANN. We guarantee that your sausage becomes a success thanks to the consistent flavour, colour and quality we provide.

Minimal loss of weight - maximum efficiency

The minimal weight loss in smoking, cooking, roasting and baking processes maximises cost-effectiveness when FESSMANN technology is used. Optimum insulation and fast process times also ensure a high level of energy efficiency. The durability of our machines provides even more benefits - we only use top-grade components which are processed under the most stringent quality requirements.

Innovation and pioneering spirit

We love racking our brains for ideas that optimise your processes. For this purpose, FESSMANN has its own research and development department. This is where we pour our passion into innovations such as the especially environmentally friendly **ECO.LINE** smoking system. With our pioneering spirit, we have set global standards that are reflected in a number of patented detailed technical solutions. Despite our achievements, we still strive to improve further so that we can continue to offer you products that save you costs and resources.



Service and experience

Your purchase is a commitment for life. When you choose FESSMANN, you will always have a competent partner at your side. You can rely on our experience. Right from the start, we support you in planning and adapting the right solution to your needs. You will, however, rarely see our customer service personnel. This is not due to their lack of time for you but rather owed to the fact that our systems are very fail-proof and extremely low-maintenance.

Flexibility and safety

You would like to change your product portfolio? Not a problem with FESSMANN. The modular design of our systems allows them to be expanded flexibly according to your needs at any time. With our intelligent **FOOD.CON** control system, you can easily manage your FESSMANN equipment around the clock. Even when it's not crunch time.



Experience you
can taste.





“Good flavour is the most important thing for us. Especially if we can achieve it with less weight lost and even lower consumption.”

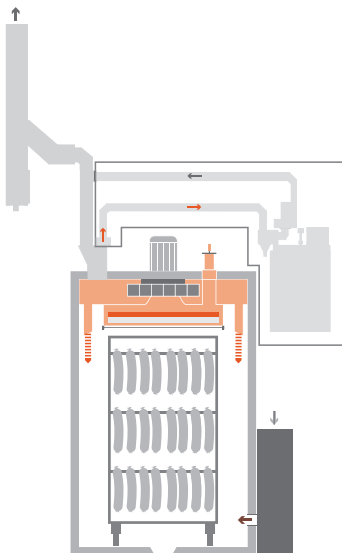

RATIO-TOP Smouldering smoke generator

- Short smoking times thanks to the rapid generation of maximum smoke concentrations
- Adjustable smoke intensity
- Various smoke flavourings and colour nuances
- TOP selection via **FOOD.CON** control:
 - TOP 1: Light smoke
 - TOP 2: Medium smoke
 - TOP 3: Intensive smoke
- Consistent top-grade product quality in colour and flavour
- Low costs, economical consumption of smoking material
- Grain size of the wood chips ranges from 4 to 12 mm (KL 2/16)
- Automatic cleaning device

Patented smoker solutions

Patented smoke generators are our strength. The sophisticated smoking system achieves optimal results in a very short time. The adjustable smoke intensity levels allow for a variety of smoke flavourings and colour nuances. Thanks to the **FOOD.CON** control system, this consistently high product quality can be reproduced both in colour and in flavour.

Depending on your requirements, you can choose between smouldering smoke generators (RATIO-TOP), friction smoke generators (RATIO-FRICTION), liquid smoke generators (RATIO-LIQUID) and steam smoke generators (RATIO-STEAM).

Scope of application

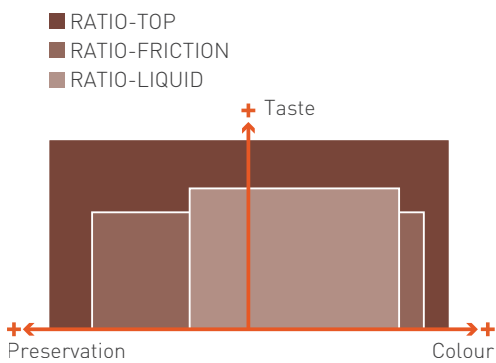

Smoke development

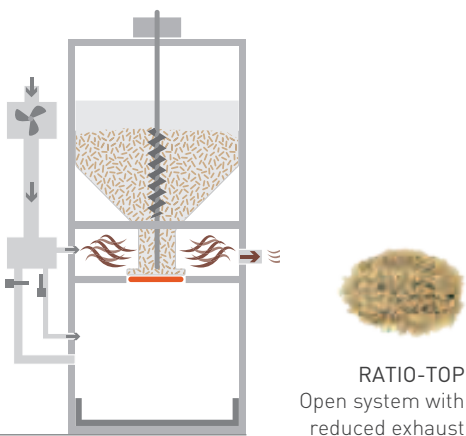
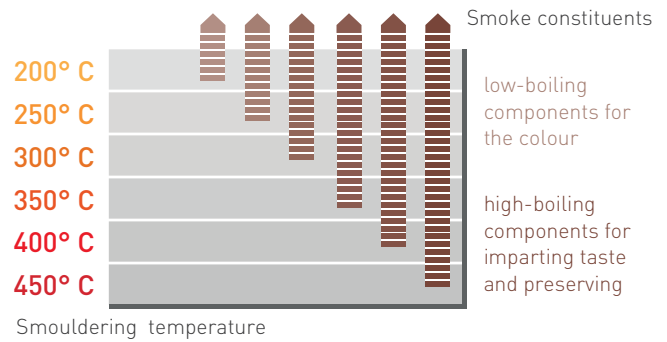

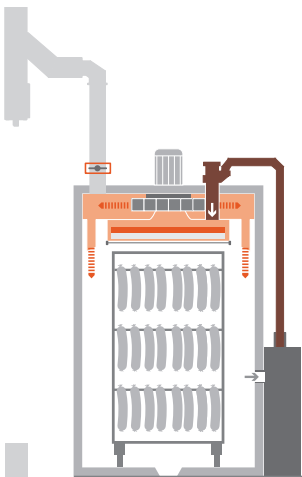

RATIO-FRICTION Friction smoke generator

- Mild smoke aroma
- Adjustable smoke intensity levels thanks to smoke interval control
- Automatic cleaning device
- Cost-effective smoking material, beech wood beams, grade II 80 x 80 x 800 mm or 80 x 100 x 1000 mm
- Low consumption
- Low noise
- Friction wheel with unrivalled service life
- Motor with lower power consumption than conventional systems
- Includes a magazine for spare beams

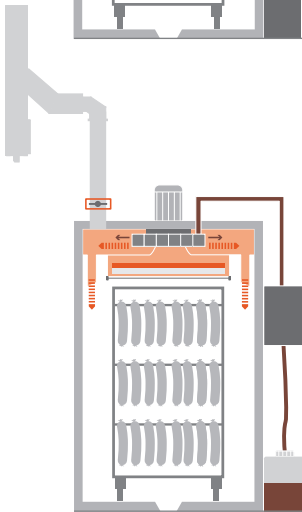

RATIO-LIQUID Liquid smoke generator

- Low acquisition costs
- Premium product quality: finest atomisation by means of the maintenance-free maximum-availability injection valve developed in house
- Minimal consumption of liquid smoke concentrate
- FESSMANN system: during smoking, the system works as a hermetically sealed system with full temperature control

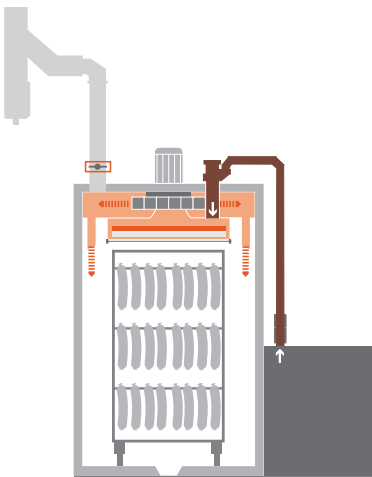

RATIO-STEAM Steam smoke generator

- Short smoking times
- Tender casing - high product quality thanks to low-pressure steam
- Sturdy design
- Easy to handle
- Easy to clean thanks to easy access for maintenance
- Grain size of the wood chips ranges from 4 to 12 mm (KL 2/16)

Technical data

SMOKE GENERATOR	RZ325	RZ550	RR325	RRi550	FR325	RATIO-STEAM	RZ7/2
T3000 1-2 trolleys	x		x		x	2 or more trolleys	
T3000 3-6 trolleys		x		x	x	x	x
Ti3000 3-6 trolleys		x		x	x	x	x
Gourmet-Master 1-2 trolleys	x		x		x	2 or more trolleys	
Gourmet-Master 3-6 trolleys		x		x	x	x	x



Friction smoke generation



Automatic cleaning device for RZ550

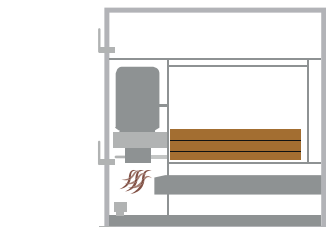

RATIO-FRICTION
Closed system

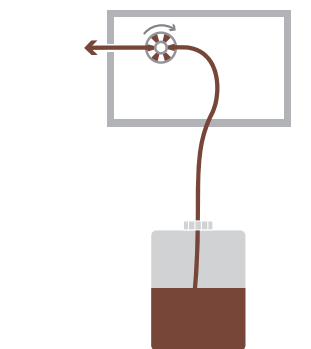

RATIO-LIQUID
Closed system

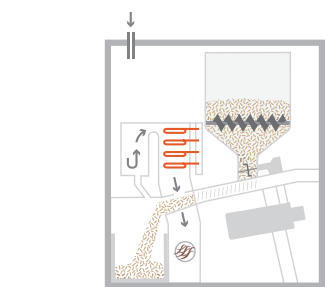

RATIO-STEAM
Open system with
reduced exhaust





Automatic door opener



Stainless steel door handle

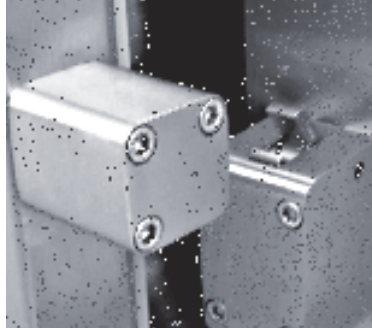

Stainless steel door lock



FESSMANN hygienic floor



“The system was adapted to our needs and grows with us as needed. This is what future-oriented investment means.”

Quality based on tradition

Modern butcher's businesses face the challenge of having to produce high quantities at a consistently high quality and as low a price as possible. Turbomat **T3000** by FESSMANN can help you achieve both: Quality and productivity.

The proven FESSMANN technology with a stepless recirculating fan ensures an exquisite smoky flavour and accurately reproducible results. Minimal weight loss, fast process times and low maintenance and operating costs make this universal system profitable in no time. The automatic control allows you to manage the system easily with minimal manpower. If your capacities increase, the system grows with you thanks to its modular design. With our variety of models and features to choose from, the Turbomat universal system can be suited to your needs perfectly.

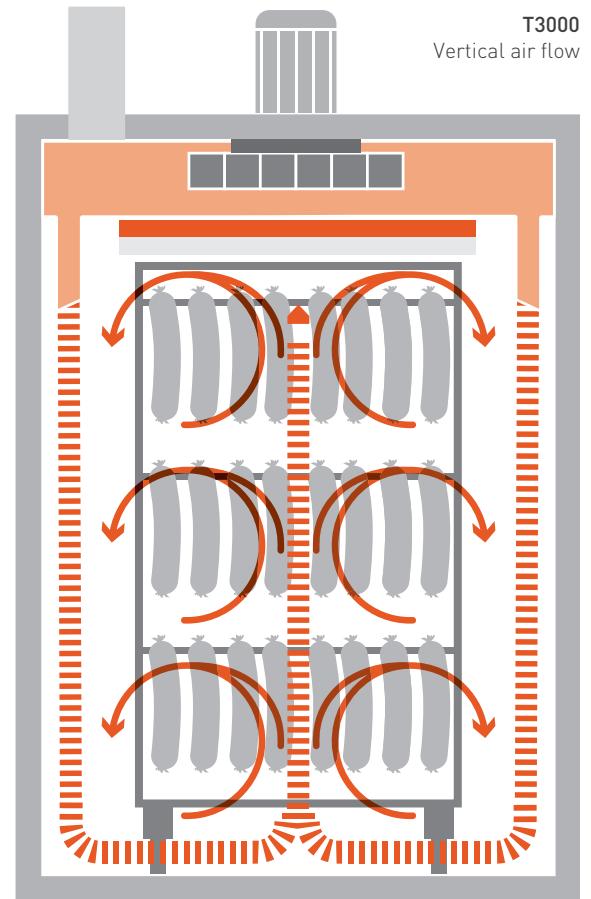

All benefits at a glance

- Made from all stainless steel with low installation height
- Automatic cleaning as standard feature
- Different means of heating available
- Optional with climate package for optimum maturation
- Stepless recirculating fan for best results and uniform smoking climate in the entire system
- Proven control mechanisms for reproducible results as standard feature
- Modular design for flexible expansion of up to 6 trolleys. Each expansion part includes its own heating and recirculation components for short production times with maximum quality
- Compatible with all smoke generators from the RATIO line

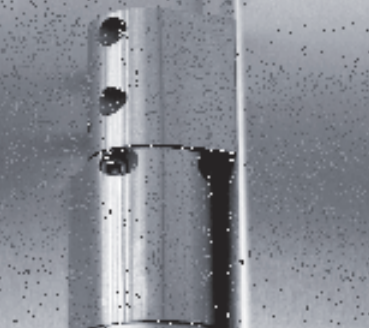

Stainless steel lifting hinge



Unique FESSMANN air flow

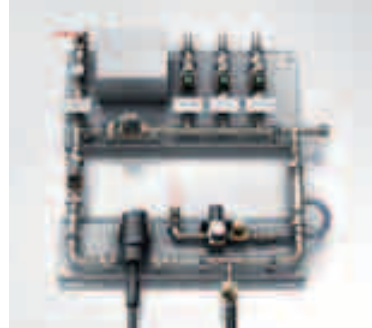

Automatic CIP cleaning



FESSMANN RATIO flap

“Up to 1.5 % higher yield with a consistent level of quality. That pays off.”

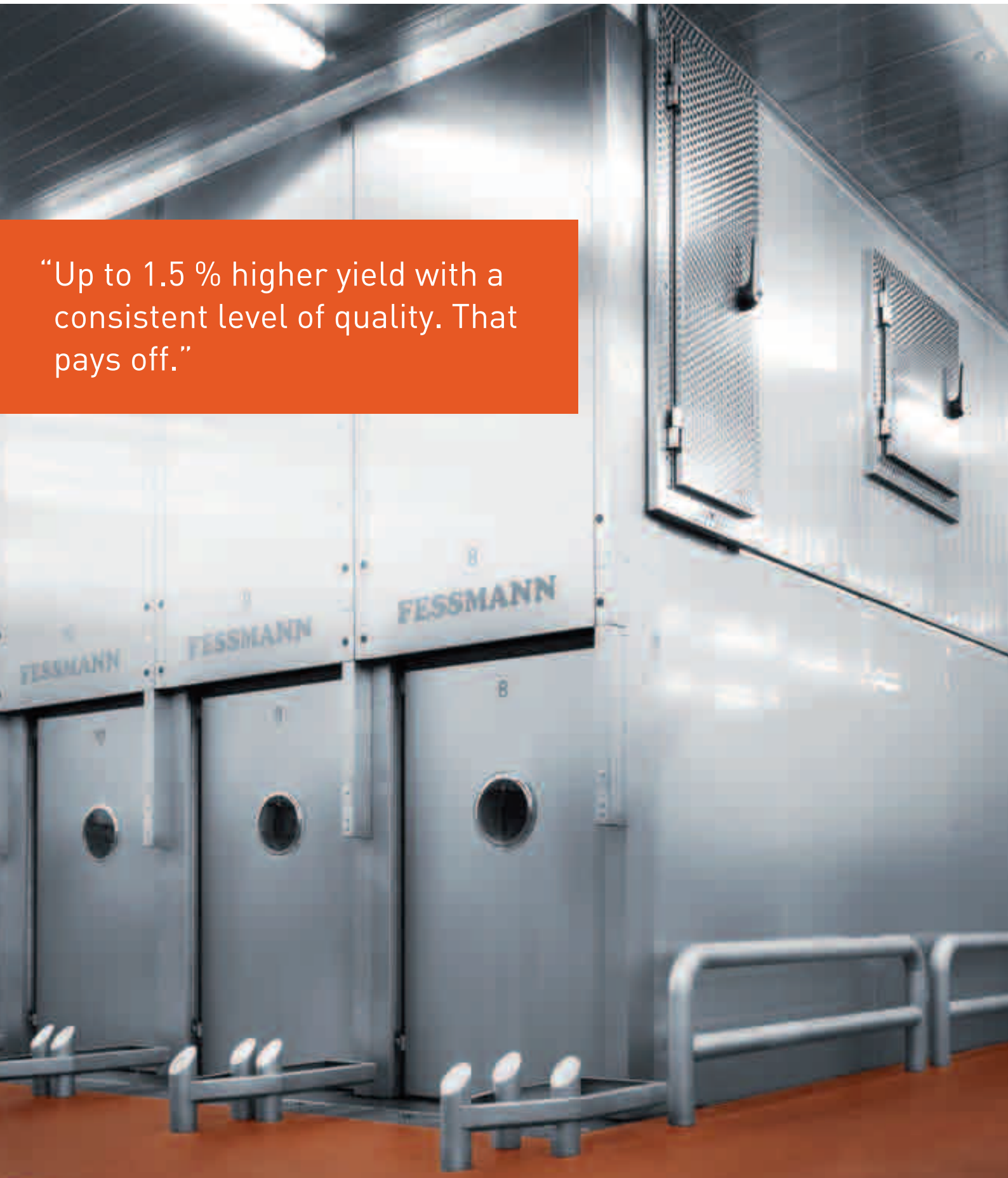

More flavour, more weight, more FESSMANN

The **Ti3000** industrial system generates 1.5 % more yield than other systems while maintaining the proven FESSMANN quality. Manufactured from all stainless steel and in steam-tight panel construction, the Ti3000 can be used for universal applications and specific demands. The central unit technology also makes it a flexible and cost-saving system with the highest air circulation capacities and short process times.

Benefit from higher system capacities and a reduced weight loss. New ventilation technology with central air recirculation ensures effective processing and unrivalled speed in smoking times with even faster drying times. At the same time, it provides a high degree of drying, optimal flavour and highest quality. The Ti3000 is the ultimate all-rounder for meat and fish processing.

It performs complete manufacturing processes with heating, drying, reddening, smoking, roasting, baking, hot-air cooking and cooking processes as well as optional shower cooling and cooling/dehumidification functions. The intelligent **FOOD.CON** control is intuitive and precise in operation and allows 99 different product programmes and even cold smoking processes to be stored.

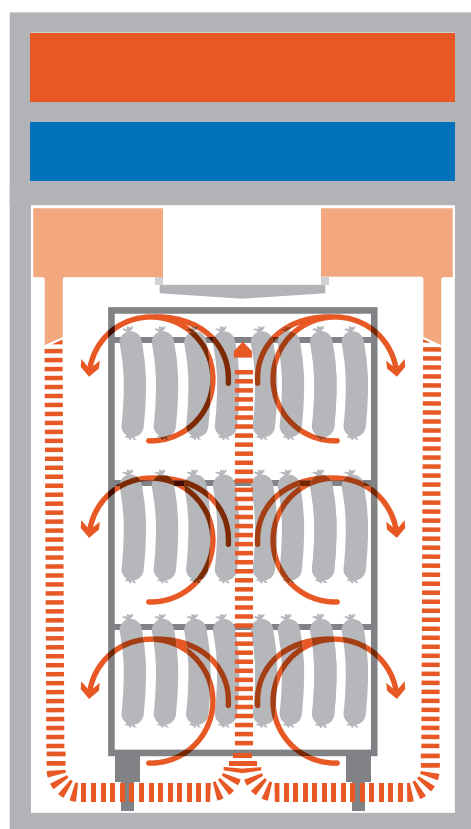

Ti3000
Vertical air flow

All benefits at a glance

- Panel construction and central unit technology for top air flow and process performance
- More flexibility in realising custom product requirements thanks to stepless fan speed adjustment
- Higher system capacities due to faster process times = higher yield
- Compatible with all types of feed trolleys for industrial use
- Use of "extra long" feed trolleys and transport frames
- Automatic door opener as standard feature
- Automatic CIP cleaning system as standard feature

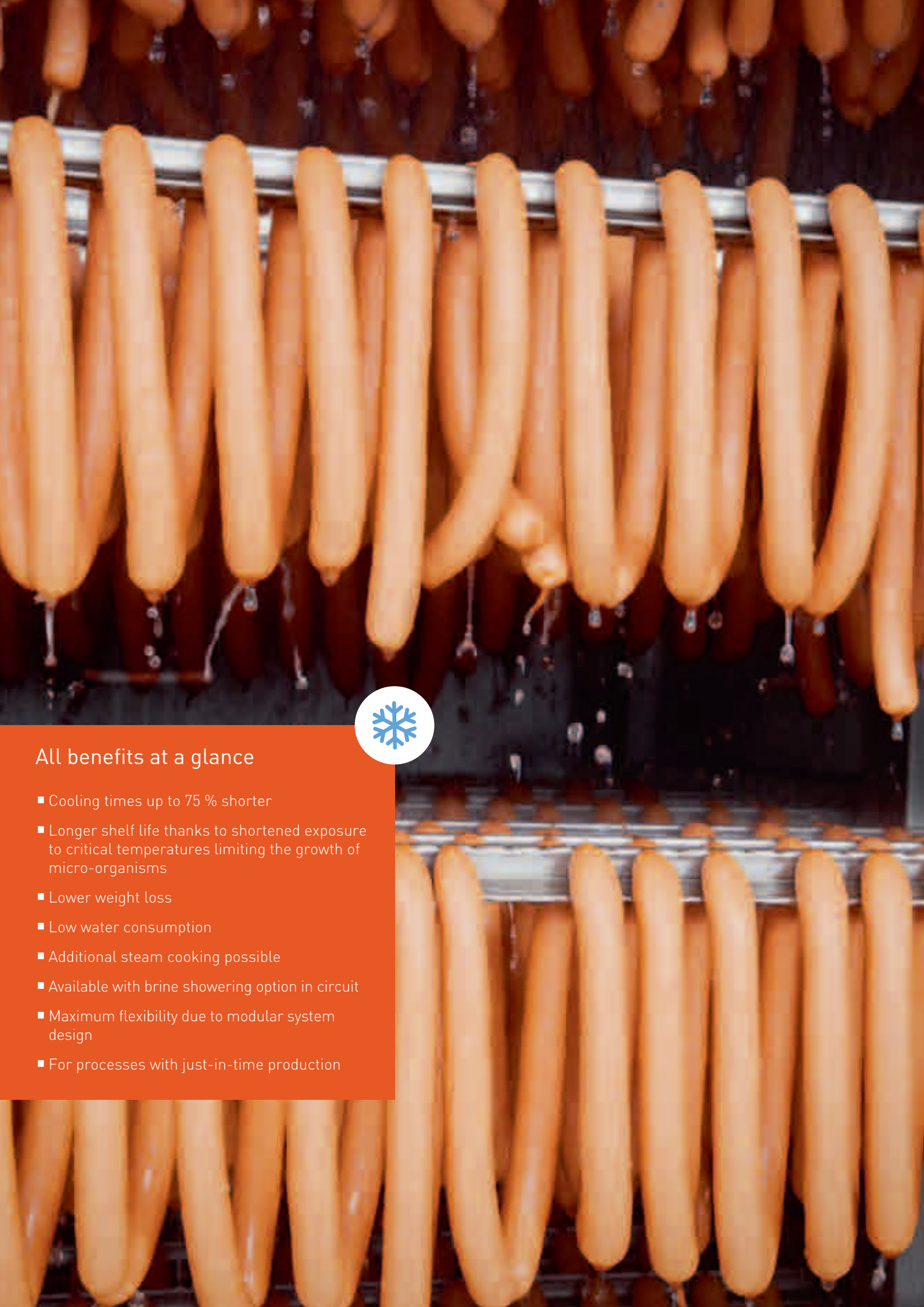

All benefits at a glance

- Cooling times up to 75 % shorter
- Longer shelf life thanks to shortened exposure to critical temperatures limiting the growth of micro-organisms
- Lower weight loss
- Low water consumption
- Additional steam cooking possible
- Available with brine showering option in circuit
- Maximum flexibility due to modular system design
- For processes with just-in-time production

A successful combination

The **TF3000** and **TFi3000** systems offer a cost-effective combination of smoking, cooking and chilling. Automated processes increase production capacities and lower operating costs. The freshly filled smoke trolley is manually moved to the first storage place in the front chamber and from there it is pulled to the centre using the pneumatic conveyance system. Then the process control is activated and the predefined treatment programme is started. The heating process now runs automatically. Once this phase is completed, the trolley is automatically moved into the cooling zone. Depending on their properties and intended type of packaging, the products are immediately cooled down to their packaging temperature in a just-in-time process via continuous shower, interval shower or cold air. At the same time, the next batch can be treated in the scalding and smoking chamber.

Production stages of a
TFi3000 (lifting door in centre)

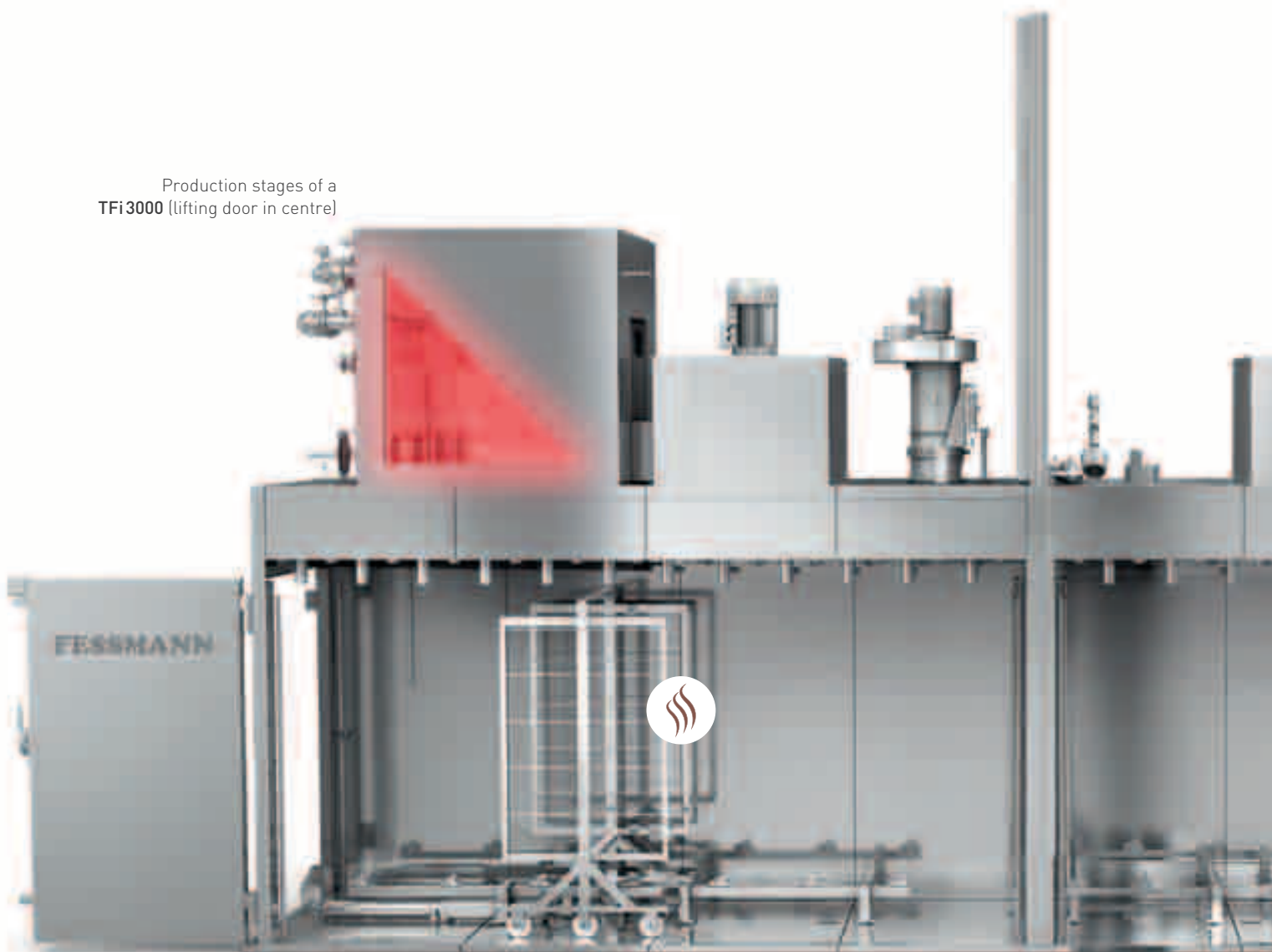

Scalding and smoking chamber Ti3000



Stainless steel impact protection



Frequency converter



Pneumatic conveyance



Lamp post

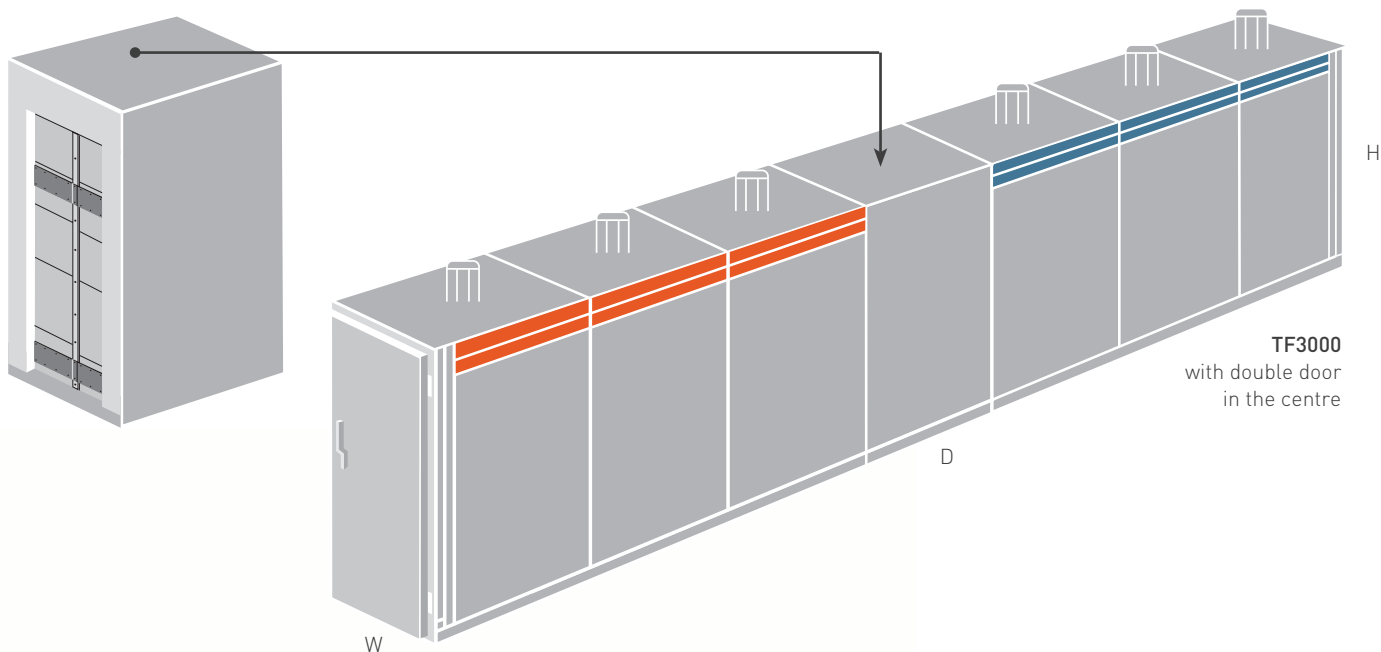

Cooling zone IKi3000

All benefits at a glance

- Just-in-time production, controllable process with reproducible processing sequence
- Significant reduction of germ formation and contamination - therefore longer shelf life
- Automated conveyance system
- Production, packaging and delivery within very short periods
- Lower requirement of refrigerating chamber capacities
- Higher loading capacity than comparable floor-mounted conveyor systems thanks to low construction



Catwalk



Loading section with water shower



Stainless steel baskets



TRANS.CON



All benefits at a glance

- Significant energy savings
- Compatible with all smoking systems
- Only 25 % of the space requirement of batch processing systems - for maximum return on minimal space
- Fully automated control and monitoring of production processes
- Temperature and humidity can be regulated separately in each processing zone
- Unsurpassed hygiene, separation of product entry and exit (HACCP)
- Excellent quality in colour and flavour with less weight loss than other batch processing systems
- Option to automate loading and unloading
- Consistently high product quality increases process and quality reliability
- Short installation and commissioning times

Continuous progress

The multifunctional **TF4000** by FESSMANN combines the basic elements of meat product manufacturing: Smoking, scalding, chilling. In the TF4000 continuous transfer system, products pass through several heat treatment and cooling sections, more specifically the drying, smoking, shower cooling and chilling zones, and leave the system ready for packaging. As an option, the heat treatment elements can be equipped with any FESSMANN components for drying, smoking and scalding. The cooling elements can be equipped with showers, air cooling equipment, circulation fans or brine showers.

Automated processes increase production capacities and reduce operating costs to a minimum. Steps such as loading, unloading or transporting and cleaning the feed trolleys are no longer necessary. Technically, personnel is only needed for the feed and to monitor the production processes.

Production stages of a **TF4000**
(8-chamber transfer)

 Temperature and humidity can be regulated separately in each chamber section.

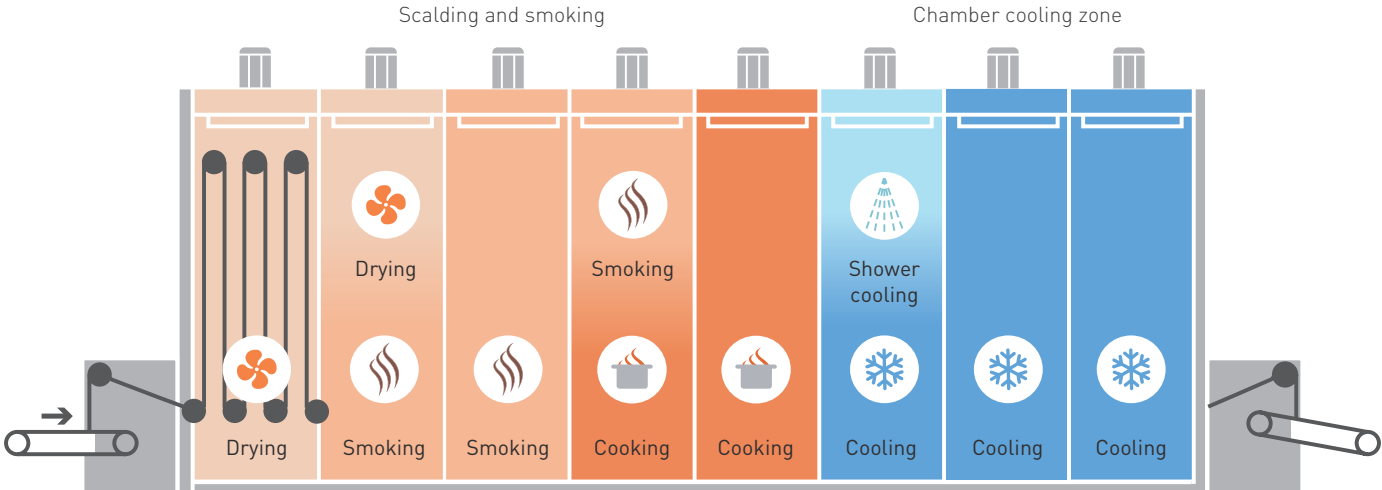

Sample product data

Wieners: Calibre: 20 mm, length 120 mm, weight: 34 g, capacity: 2329 kg/h.



Pork pâté loaf



Chicken wings



Crustrated ham



Whole chicken



All benefits at a glance

- Optimal baking results thanks to unique rotation technology
- Increases capacities up to 100 %
- Short heating and baking times
- Up to twice the trolley load capacity of standard baking systems
- Lower weight loss than conventional systems (amortisation of investment costs from only the weight loss savings is possible in less than 6 months)
- Less space required
- Energy savings thanks to high-quality insulation
- Optional CIP cleaning to reduce personnel expenditures

Our secret: Baking at 360 °

The FESSMANN **RotathermCarat** stands for top-class baking results thanks to its special rotation baking technology. This unique system combines the innovative baking trolley rotation with the air flow from three vertical outlets directed at the centre (see image). This makes it suitable for baking, cooking and hot-air refining in batch operation.

Increase your profits and lower your costs with FESSMANN RotathermCarat. Discover the premium quality and maximum capacity yourself.

The innovative technology allows for the development and design of completely new products, such as pâtés or combinations of meat and dough. Produce crunchy surfaces with an artisan flavour but no burn marks. Thanks to Slicerware, loosening the baking crust is no longer a problem. No more wasted goods. The particularly short heating and baking times, the excellent insulation and the long shelf life also save you energy and money. Furthermore, this system not only significantly reduces weight loss but also the floor space needed.

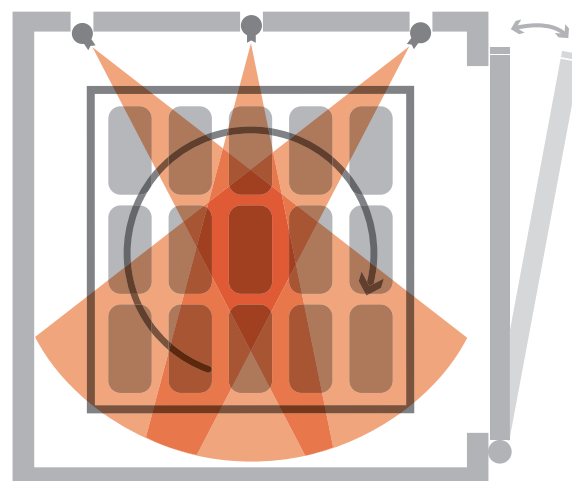

RotathermCarat
Top view

Technical data

RotathermCarat ¹⁾		
DIMENSIONS		
Floor space (W × D)	cm	198 × 187
Body height	cm	251
Minimum room height	cm	335
Recommended room height	cm	-
Baking trolley (H × W × D)	cm	198 × 103 × 104
Baking tray (W × D)	cm	94 × 100
HEATING CAPACITY		
Connection value for EL heat	kW	88
Connection value for gas heat	kW	80
+ additional EL heat	kW	24
Connection value for oil heat	kW	80
+ additional EL heat	kW	24
Connection value for LP heat	kW	45

¹⁾ This data is merely a summary and must not be used for structural application. Please see the relevant dimension sheets for complete dimensions and power connections. EL = heated electrically, oil = heated with oil, gas = heated with gas, LP = low pressure.

RotathermCarat



Conventional baking system



The patented system for guaranteed flavour

Wherever large volumes are produced, particularly innovative ideas are needed to guarantee the unique quality. Our patented **AUTOVENT3000** system was therefore designed especially for industrial purposes.

The highlight: FESSMANN AUTOVENT3000 nozzles utilize the momentum from the low-pressure steam and convert it into air velocity and heat energy. This allows for ideal heat transfer to the product, which results in shorter cooking times with up to 15 % less weight loss! Forgoing the fans furthermore leads to savings in energy and maintenance costs. The benefits are clear when it comes to flavour as well: the temperature difference in the system never exceeds 1 °C so that overcooking is no longer a problem. Your customers will thank you for products at such an outstanding price-performance ratio.

By the way: The modular design of FESSMANN systems makes an expansion up to 12 trolleys possible. This means that you can cost-effectively expand production at low investment costs.

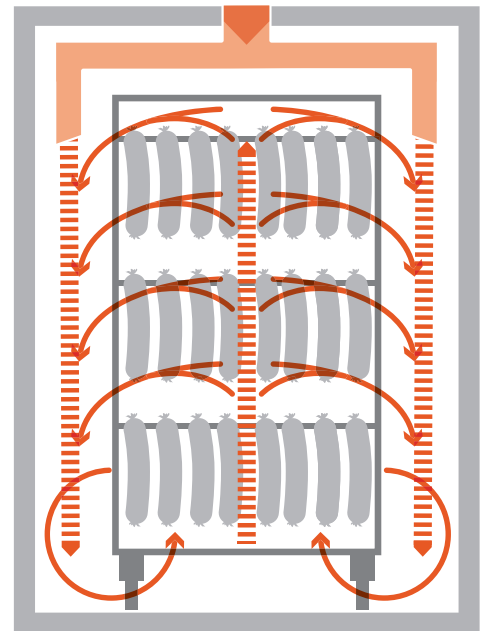

AUTOVENT3000
with low pressure steam technology

Technical data

AUTOVENT-COOKING SYSTEMS ¹⁾		AUTOVENT3000					
DIMENSIONS		1 TROLLEY	2 TROLLEYS	3 TROLLEYS	4 TROLLEYS	5 TROLLEYS	6 TROLLEYS
Floor space HP heating (W × D)	cm	151 × 136	151 × 246	151 × 356	151 × 466	151 × 576	151 × 686
Body height	cm	273	273	273	273	273	273
Recommended room height	cm	370	370	370	370	370	370
Smoke trolley dimensions (H × W × D)	cm	198 × 104 × 102	198 × 104 × 102	198 × 104 × 102	198 × 104 × 102	198 × 104 × 102	198 × 104 × 102
Max. stick length		100	100	100	100	100	100
CONNECTION VALUES							
Connection value LP heat	kW	44.5	89	133.5	178	222.5	267

¹⁾ This data is merely a summary and must not be used for structural application. Please see the relevant dimension sheets for complete dimensions and power connections. HP = heated with high pressure steam, LP = low pressure.



All benefits at a glance

- The patented AUTOVENT nozzles accelerate the low-pressure steam to 200 m/s, thus creating a high level of turbulence in the system. This allows for ideal heat transfer to the product, which results in shorter cooking times with up to 15 % less weight loss but higher capacities.
- The temperature difference in the system never exceeds 1 °C, which leads to perfectly even products of the highest quality.
- AUTOVENT systems work without fans. This keeps maintenance and operating costs to a minimum.
- The system is completely made from stainless steel and has been welded steam-tight. This ensures a long service life and keeps energy consumption low.



All benefits at a glance

- Easy operability: intuitive, clear and ergonomic programme outline
- Maximum availability and limited downtime thanks to self-diagnostics
- Remote maintenance by external access allows for service and programme optimisations around the clock
- Always precise and easy to see on the display during ongoing programs: progress of chamber temperature, core temperature and moisture level
- Improved temperature control
- Batch input option
- Multi-system operation possible with **FOOD.CoN Touch**
 - FOOD.CoN Touch 12"** :
 - up to 4 systems
 - FOOD.CoN Touch 15"** :
 - up to 12 systems
- Touch screen with special protective glass: easy operation and protection from moisture
- Various levels of password protection safeguard the programmes against unauthorised access





FOOD.CON – easy, intuitive, precise

The new **FOOD.CON** control looks good, is easy to handle and keeps quality consistently high.

Producing high-quality products in the meat processing industry means to balance the demand for flexibility in the manufacture of goods and ultimate process reliability. Constant monitoring of all processes and flow of goods without breaks as well as the careful documentation of each interference in the programme sequence are of the utmost importance: It is the only way to prevent mistakes that may lead to more severe downtimes or high costs later. To achieve this, we need software that stays in control even with the high number of processes running at the same time, the multitude of systems and the ever increasing requirements for process control that rise under pressure.

Being in the know with FOOD.LOG

The process monitoring software developed by FESSMANN offers user-friendly, Windows-based control mechanisms to simplify complex production sequences. **FOOD.LOG** gives you a comprehensive overview over all data required for the quality assurance of your products. It is ergonomic and intuitive and saves all relevant data in a database, thus making it easy to monitor multiple systems at the same time.

The right programme for each company. You can choose between **FOOD.LOG** basic, professional and enterprise to meet your individual needs for production monitoring. Perfect easy-to-handle process monitoring – with **FOOD.LOG**, you won't miss a thing. You can document any system and operating condition in a detailed manner. The programme records and saves all process-related data, such as chamber temperature and core temperature, F value, process duration and relative humidity. **FOOD.LOG** allows for accurate production control and verification management according to DIN ISO 9000.

All **FOOD.LOG** features at a glance:

- Process monitoring
- Process documentation
- Verification management
- Batch reporting
- Production optimisation
- Programme maintenance
- Failure management
- System monitoring
- Integration in EN ISO 9000–9004
- Links up to 32 systems, cooling and storage rooms per PC



“We strive to not only preserve the weight of your products, but also your energy.”

ECO.LINE – An energy-efficient all-rounder

The new TURBOMAT systems by FESSMANN are particularly economical and flexible. Thanks to the advanced panel construction with Triplex insulation, heat loss was reduced by more than 20 percent.

The fully automated Cleaning-in-place system (CIP) ensures environmentally friendly and convenient self-cleaning. The frequency converter, which is a standard feature, allows the speed to be controlled individually and adds to the benefits: Different products can be processed in the same system.

Our contribution to resource conservation

- All systems feature the unique Triplex insulation: Stainless steel side wall without thermal bridges plus PU foam insulation and additional plastic insulation panel
- Smart silicone gaskets seal any opening so that energy does not escape through covers or doors.
- Energy-efficient engines in all systems according to the latest EU standard (IEC 60034-30)
- Frequency converter for gentle and efficient product treatment
- The environmentally friendly CIP system minimises water and cleaning agent consumption thanks to intelligent control technology.
- State-of-the-art control technology optimises the cooling process and reduces energy consumption while still ensuring the same product quality
- FESSMANN Ratio smoke generators need up to 50 % less smoking material with more flexible and intense smoking results.



“I am confident that the formulation and convincing technology along with the high reliability are key success factors for good sausage.”

Uli Fessmann

All benefits of FESSMANN at a glance

- Smoke density can be controlled for individual and uniform taste
- Patented smoking system achieves consistent quality in the entire batch
- Very cost-effective due to minimal weight loss and perfect uniformity
- Reproducible results thanks to **FOOD.CON** control by FESSMANN
- Accurate production control and verification management thanks to **FOOD.LOG** process monitoring software by FESSMANN
- Smoke generators individually adjusted to meet your requirements
- Long service life due to high-quality materials and good processing
- Flexibly expandable due to modular design
- Energy-efficient thanks to optimal insulation
- Future-proof: Heating optionally either with electricity, high-pressure steam, gas, thermal oil or oil



All systems at a glance.
Just fold open.

Technical data

T3000 ¹⁾		T3000/3	T3000/4	T3000/5	T3000/6
DIMENSIONS		3 TROLLEYS	4 TROLLEYS	5 TROLLEYS	6 TROLLEYS
Floor space HP heating (W x D)	cm	151 x 356	151 x 466	151 x 576	151 x 686
Height with EL / HP heating, body	cm	250	250	250	250
Height with gas / oil heating, body	cm	265	-	-	-
Minimum room height EL / HP heating	cm	439	451	451	451
Recommended room height EL / HP heating	cm	439	451	451	451
Smoke trolley dimensions (H x W x D)	cm	198 x 104 x 102	198 x 104 x 102	198 x 104 x 102	198 x 104 x 102
Max. stick length	cm	100	100	100	100
HEATING CAPACITY					
Connection value for HP heat	kW	102	136	170	204
Connection value for EL heat	kW	85.05	113.4	141.75	170.1
Connection value for gas heat	kW	90	-	-	-
Connection value for oil heat	kW	90	-	-	-

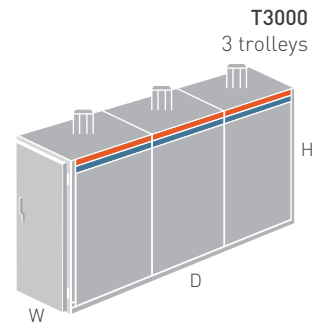

Ti3000 ¹⁾		Ti3000/3	Ti3000/4	Ti3000/5	Ti3000/6
DIMENSIONS		3 TROLLEYS	4 TROLLEYS	5 TROLLEYS	6 TROLLEYS
Floor space HP heating (W x D)	cm	151 x 356	151 x 466	151 x 576	151 x 686
Height with EL / HP heating, body	cm	273	273	273	273
Height with gas / oil heating, body	cm	273	-	-	-
Minimum room height EL / HP heating	cm	450	450	450	450
Recommended room height EL / HP heating	cm	500	500	500	500
Smoke trolley dimensions (H x W x D)	cm	198 x 104 x 102	198 x 104 x 102	198 x 104 x 102	198 x 104 x 102
Max. stick length	cm	100	100	100	100
HEATING CAPACITY					
Connection value for HP heat	kW	135	180	225	270
Connection value for EL heat	kW	118.8	158.4	158.4	-

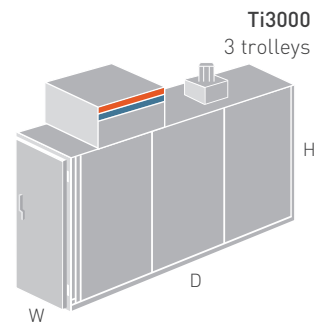

TF3000 ¹⁾		2+2 TROLLEYS		3+3 TROLLEYS		4+4 TROLLEYS		5+5 TROLLEYS		6+6 TROLLEYS	
DIMENSIONS		DD	LD	DD	LD	DD	LD	DD	LD	DD	LD
Floor space HP heating (W x D)	cm	151 x 586	151 x 514	151 x 806	151 x 734	151 x 1026	151 x 954	151 x 1246	151 x 1174	151 x 1466	151 x 1394
Body height	cm	250	250	250	250	250	250	250	250	250	250
Minimum room height EL / HP heating	cm	413	550	439	550	451	550	451	550	451	550
Smoke trolley dimensions (H x W x D)	cm	198 x 104 x 102									
Max. stick length	cm	100									
HEATING CAPACITY											
Connection value for HP heat	kW	68		102		136		170		204	
Connection value for EL heat	kW	56.7		85.05		113.4		141.75		170.1	

TFi3000 ¹⁾		3+3 TROLLEYS		4+4 TROLLEYS		5+5 TROLLEYS		6+6 TROLLEYS	
DIMENSIONS		DD	LD	DD	LD	DD	LD	DD	LD
Floor space HP heating (W x D)	cm	151 x 806	151 x 734	151 x 1026	151 x 954	151 x 1246	151 x 1174	151 x 1466	151 x 1394
Body height	cm	273	273	273	273	273	273	273	273
Minimum room height EL / HP heating	cm	450	550	450	550	450	550	450	550
HEATING CAPACITY									
Connection value for HP heat	kW	135		180		225		270	
Connection value for EL heat	kW	118.8		158.4		158.4		-	

¹⁾ This data is merely a summary and must not be used for structural application. Please see the relevant dimension sheets for complete dimensions and power connections. HP = heated with high pressure, EL = heated electrically, oil = heated with oil, gas = heated with gas, FT = double door in centre, HT = lift door in centre.

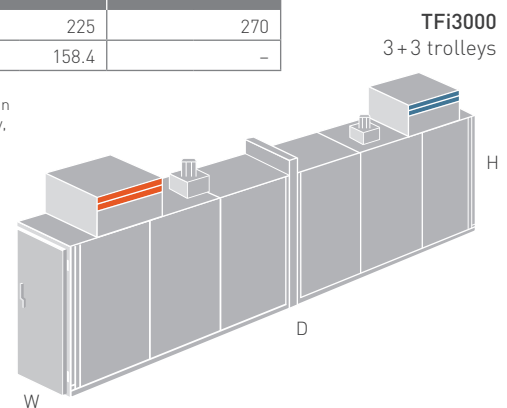

FESSMANN GmbH & Co KG

Herzog-Philipp-Straße 39, D-71364 Winnenden, Phone +49 (0) 7195 701-0,
Fax +49 (0) 7195 701-105, info@fessmann.de, www.fessmann.de

Subject to technical modifications, system photos may deviate from standard, version 02/2015